



KRAMER ELECTRONICS LTD.

USER MANUAL

MODEL:

Galil 4-CO
Open-back Ceiling Speakers

P/N: 2900-300395 Rev 4



Galil 4-CO Quick Start Guide

This guide helps you install and use your product for the first time. For more detailed information, go to http://www.kramerelectronics.com/support/product_downloads.asp to download the latest manual or scan the QR code on the left.

Step 1: Check what's in the box

- Galil 4-CO 2-way open-back ceiling speakers
- 1 Quick start guide
- Cutout template

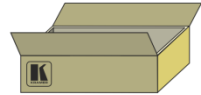

Save the original box and packaging materials in case you need to return your product for service.

Step 2: Choose the best location

Ideally, locate the speakers above the main listening area. Before doing so, be sure that:

- The desired location is free of obstructions, such as electric piping, AC ducts or water lines, and so on
- There is enough space behind the mounting surface for the speakers
- The rear side of the speakers is not blocked by wall studs or other objects

Step 3: Install the speakers

To install the speakers:

- Cut the ceiling tile
- Place the C-ring over the hole and set the C-ring tabs parallel to the tile edges
- Connect the speaker wires (parallel or daisy-chain)
- Adjust the tap setting
- Push the speaker into the ceiling hole and tighten the mounting tabs
- Secure speaker by connecting the speaker support ring to a secure anchor point

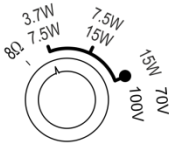

For best results, we recommend that you always use Kramer high-performance cables to connect AV equipment to your speakers

Always switch OFF the power on each device before connecting it to your Speakers.

PARALLEL WIRING

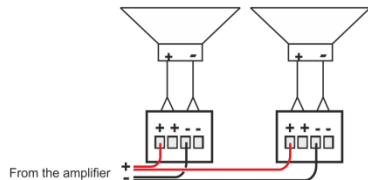

DAISY CHAIN WIRING

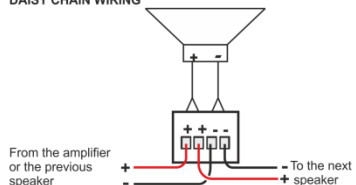

Contents

1	Introduction	1
2	Getting Started	2
2.1	Achieving the Best Performance	2
3	Overview	3
4	Your Galil 4-CO	4
5	Installing the Open-back Ceiling Speakers	5
5.1	Choosing the Best Location	5
5.2	Cutting the Ceiling Tile	6
5.3	Mounting the Open Back Ceiling Speakers	7
5.4	Array Installation	8
5.5	Painting the Speaker	11
6	Technical Specifications	12

Figures

Figure 1:	Open-back Ceiling Speakers in a Boardroom Setup	3
Figure 2:	Galil 4-CO Open-back Ceiling Speakers	4
Figure 3:	Position Mounting Tab	7
Figure 4:	Adjust Tap Selector	7
Figure 5:	Open-back Ceiling Speaker Schematic Pinout Diagram	8
Figure 6:	The Speaker Coverage Area	9
Figure 7:	Square Layout	9
Figure 8:	Hexagonal Layout	9
Figure 9:	Square Layout Parallel Wiring	10

1 Introduction

Welcome to Kramer Electronics! Since 1981, Kramer Electronics has been providing a world of unique, creative, and affordable solutions to the vast range of problems that confront video, audio, presentation, and broadcasting professionals on a daily basis. In recent years, we have redesigned and upgraded most of our line, making the best even better!

Our 1,000-plus different models now appear in 14 groups that are clearly defined by function: GROUP 1: Distribution Amplifiers; GROUP 2: Switchers and Routers; GROUP 3: Control Systems; GROUP 4: Format/Standards Converters; GROUP 5: Range Extenders and Repeaters; GROUP 6: Specialty AV Products; GROUP 7: Scan Converters and Scalers; GROUP 8: Cables and Connectors; GROUP 9: Room Connectivity; GROUP 10: Accessories and Rack Adapters; GROUP 11: Sierra Video Products; GROUP 12: Digital Signage; GROUP 13: Audio; and GROUP 14: Collaboration.

Congratulations on purchasing your Kramer **Galil 4-CO** Open-back Ceiling Speakers, which are ideal for the following typical applications:

- Presentation venues
- Training rooms
- Conference rooms
- Hotel lobbies
- Educational classrooms



Galil 4-CO is designed for indoor dry locations and is suitable for use in air handling spaces (plenum spaces).

2 Getting Started

We recommend that you:

- Unpack the equipment carefully and save the original box and packaging materials for possible future shipment
- Review the contents of this user manual



Go to http://www.kramerelectronics.com/support/product_downloads.asp to check for up-to-date user manuals, application programs, and to check if firmware upgrades are available (where appropriate).

2.1 Achieving the Best Performance

To achieve the best performance:

- Use only good quality connection cables (we recommend Kramer high-performance, high-resolution cables) to avoid interference, deterioration in signal quality due to poor matching, and elevated noise levels (often associated with low quality cables)
- Do not secure the cables in tight bundles or roll the slack into tight coils
- Avoid interference from neighboring electrical appliances that may adversely influence signal quality
- Position your Kramer Speakers away from moisture, excessive sunlight and dust



This equipment is to be used only inside a building. It may only be connected to other equipment that is installed inside a building.



Do not open the housing of the speaker; doing so may reduce the quality of the sound.

3 Overview

The **Galil 4-CO** speakers include a pair of high performance *Open-back Ceiling speakers* that can be mounted on the ceiling. The **Galil 4-CO** speakers feature a multi tap power transformer for selecting 8Ω (bypassing the transformer) or 70V/100V power settings suitable for array installation.

[Figure 1](#) shows an example of how the Open-back Ceiling speakers can be installed in a boardroom setup:

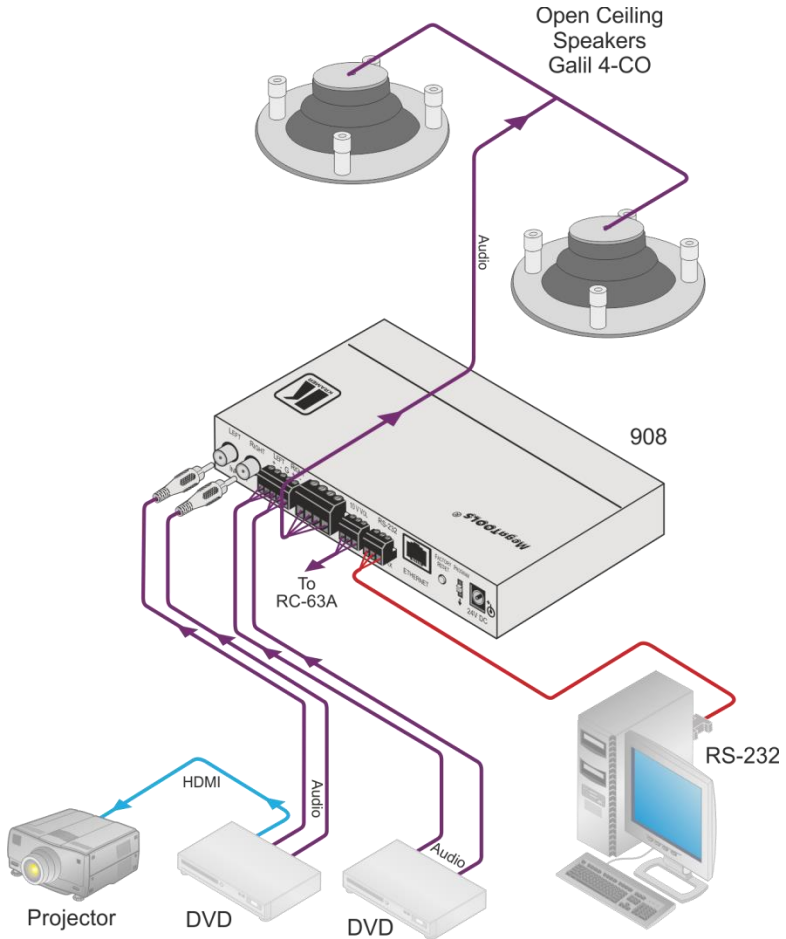

Figure 1: Open-back Ceiling Speakers in a Boardroom Setup

4 Your Galil 4-CO

Figure 2 defines the Galil 4-CO:

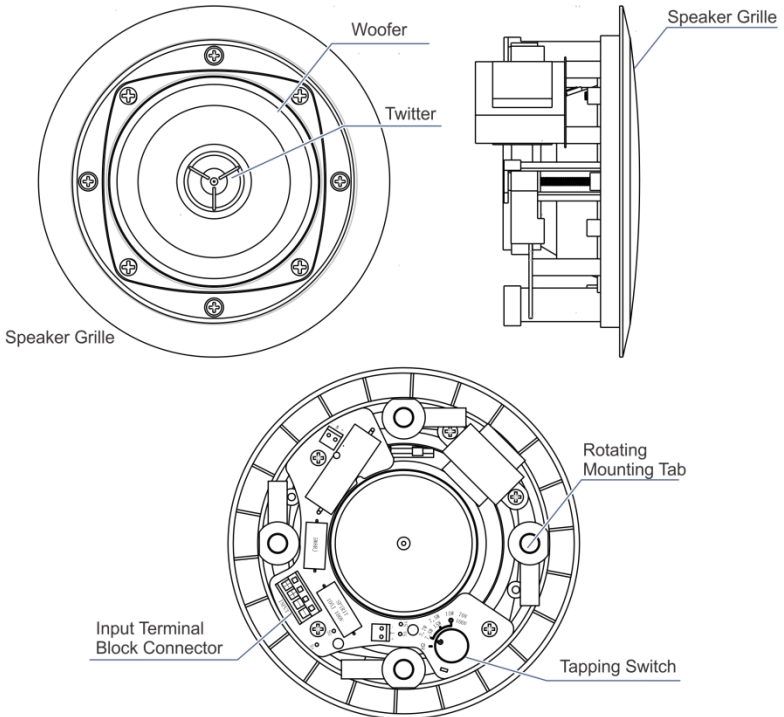

Figure 2: Galil 4-CO Open-back Ceiling Speakers

The following table defines the Open-back ceiling speaker hardware items (per speaker pair):

Description					
A pair of ceiling speakers (one shown)		Two grilles (one shown)		Cutout template	



Be sure that the tiles can support the speaker. Smaller sized tiles or fiberglass-type tiles cannot support the weight of the speakers. When this is the case, the speakers will need additional support.

5 Installing the Open-back Ceiling Speakers

This section explains how to install the Open-back ceiling speakers, that is:

- Choosing the best place to locate your speakers (see [Section 5.1](#))
- Cutting the ceiling tile (see [Section 5.2](#))
- Installing the speakers (see [Section 5.3](#))
- Array installation general guidelines (see [Section 5.4](#))
- Painting the speakers (see [Section 5.5](#))

5.1 Choosing the Best Location

Ideally, locate the speakers above the main listening area. Before doing so, be sure that:

- The desired location is free of obstructions, such as electrical piping, AC ducts or water lines, and so on
- There is enough space behind the mounting surface for the speakers
- The rear side of the speaker is not blocked by wall studs or other objects

5.2 Cutting the Ceiling Tile

To cut the ceiling tile, do the following:

1. Remove the circle in the supplied template.
Keep this template for later use as a mask, as you may want to paint the speakers (see [Section 5.4](#))
2. Mark the opening in the correct location by tracing the hole in the template.
3. Cut out the hole according to the template or with a circular cutter set to the appropriate cutout size.
Initially, you can cut a smaller area inside the marked hole just to be sure that the space above the speakers is clear
4. Route the wiring from the amplifier to the speakers' cutout holes, taking care not to place them next to electrical wires or at least at a distance of about two feet from an AC line.



Do not nail or staple the speaker wires.

If you are mounting the speakers onto a ceiling tile, remove the ceiling tiles where you plan to install the speakers. Use the template to trace and then cutout the speaker hole over an empty box.



Be sure that the tiles can support the speaker. Smaller sized tiles or fiberglass-type tiles cannot support the weight of the speakers. When this is the case, the speakers will need additional support.

When mounting onto a sheetrock ceiling, the C-ring alone is used to reinforce the ceiling material.

5.3 Mounting the Open Back Ceiling Speakers

To mount the 2-way Open-back Ceiling speakers, do the following:

1. Position the mounting tabs (see [Figure 3](#)) inward.

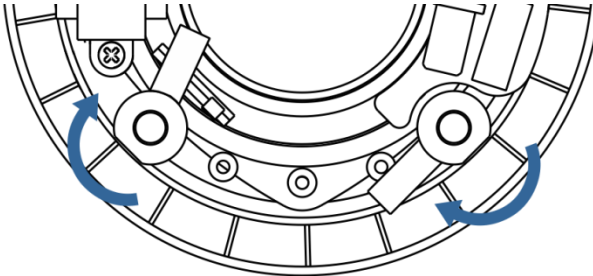

Figure 3: Position Mounting Tab

2. Adjust each speaker to the appropriate tap setting (see [Figure 4](#)).
Set the tap according to the power requirements of the speaker based on its location in the room (for example, a speaker located in a remote corner may require additional power)

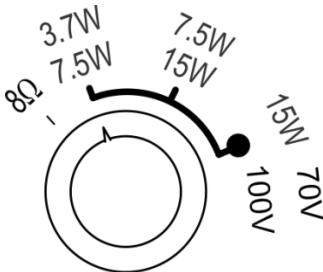

Figure 4: Adjust Tap Selector



For 100V installations, DO NOT set the tapping switch beyond 15W. Doing so may cause damage to both the speaker and the amplifier.

3. Insert the supplied screws into the screw openings from the front of the speakers.
4. Connect the speaker wires to the speaker terminals.

[Figure 5](#) shows a schematic diagram of the Closed-back ceiling speaker Pinout:

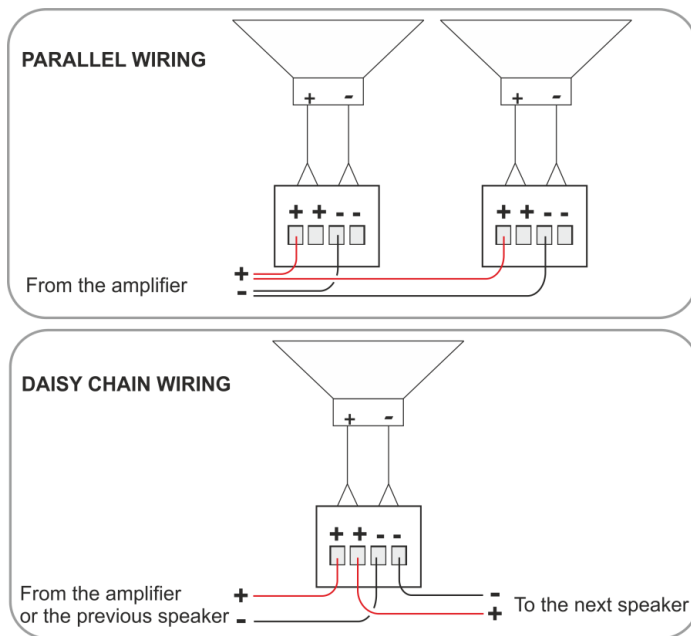

Figure 5: Open-back Ceiling Speaker Schematic Pinout Diagram

5. Insert the speaker into the opening and tighten the screws.
When tightening the screws, the tabs automatically turn outward, thus clamping the speaker to the wall from its rear side.



Do not over-tighten the screws. It may cause damage to both the speakers and the surface.

5.4 Array Installation

When installing **Galil 4-CO** in an array installation layout, you have to define the distance between speakers as well as the layout pattern (square or hexagonal). The distance between speakers is set according to the speakers' coverage angle (see [Figure 6](#)), the uniformity of the coverage desired and the budget.

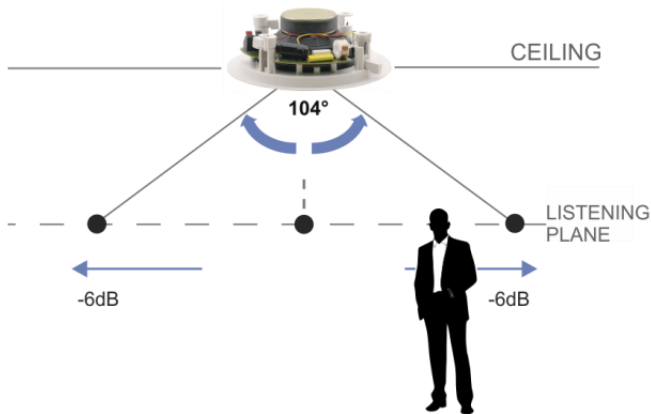

Figure 6: The Speaker Coverage Area

The coverage angle of the speaker determines the coverage area and the number of speakers required in the array installation. Two patterns are usually used for array installations, square (see [Figure 7](#)) or hexagonal (see [Figure 8](#)), depending on the shape of the installation area. The speakers are positioned according to their coverage area.

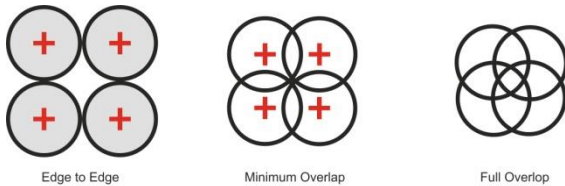

Figure 7: Square Layout

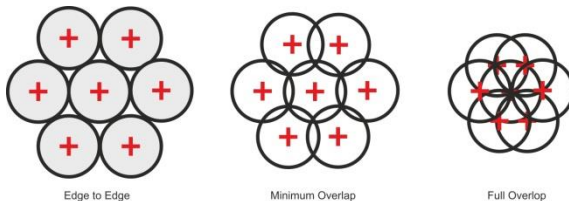

Figure 8: Hexagonal Layout

You can set the power on each speaker to get the desired power level in different installation areas.

Figure 9 shows an example of parallel wiring in a square array installation:

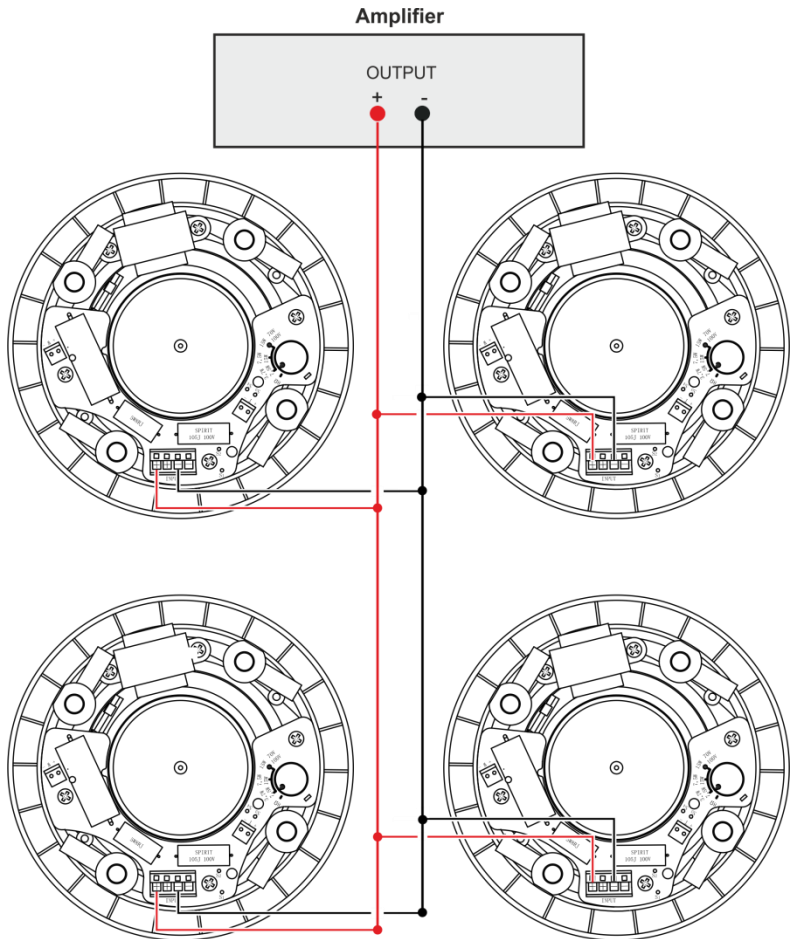

Figure 9: Square Layout Parallel Wiring

5.5 Painting the Speaker

You can paint the speakers before or after the speakers are installed. When painting before installation:

- Clean the rim and grille with mineral spirits or other light solvent that is unlikely to damage the surface
- Spray with color by holding the spray can at an angle of 45°



When spraying the grille, take care not to clog the holes in the grille as this will greatly reduce the sound quality of the speakers.

When painting after installation:

- Use the circle that you cut out of the template as a paint mask
- After you finish painting, remove the paint mask

6 Technical Specifications

Galil 4-CO	
Audio and Power	
DESCRIPTION:	2-Way open-back ceiling speakers
FREQUENCY RESPONSE:	60Hz to 20kHz @ -10dB 80Hz to 20kHz @ ± 3 dB
WOOFER:	4" (103mm) polypropylene with rubber surround
TWEETER:	0.5" (13mm) Mylar
IMPEDANCE:	8 Ω (transformer tap in off position)
TRANSFORMER TAPS:	70V – 15W / 7.5W / 3.7W / Off (Lo-Z) 100V – 15W / 7.5W / Off (Lo-Z)
SENSITIVITY:	83dB SPL, 1W@1m
MAX SPL:	Continuous: 95dB Peak: 98dB
POWER HANDLING:	15W RMS 40W continuous program
CROSSOVER FREQUENCY:	13kHz
COVERAGE ANGLE:	104°
DIRECTIVITY FACTOR (Q):	8, averaged 1kHz to 10kHz
DIRECTIVITY INDEX (DI):	9dB averaged 1kHz to 10kHz
INPUT CONNECTOR:	Terminal block
Shipping and Installation	
MATERIALS:	Frame, aluminum grille, safety cord attached to grille
OPERATING TEMPERATURE:	0° to +40°C (32° to 104°F)
STORAGE TEMPERATURE:	-40° to +70°C (-40° to 158°F)
HUMIDITY:	10% to 90%, RHL non-condensing
WEIGHT PER SINGLE SPEAKER:	0.95kg (2.09lbs) approx.
SHIPPING WEIGHT (FOR PAIR):	2.6kg (5.73lbs) approx.
DIMENSIONS:	External diameter: 16.7cm (6.57"); cutout diameter: 13.9cm (5.47")
INSTALLATION CLEARANCE:	Mounting depth: 6.82cm (2.7")
INCLUDED ACCESSORIES:	Cutout template
COLORS:	Available in white
Specifications are within a 10% tolerance and are subject to change without notice at http://www.kramerelectronics.com	

LIMITED WARRANTY

The warranty obligations of Kramer Electronics for this product are limited to the terms set forth below:

What is Covered

This limited warranty covers defects in materials and workmanship in this product.

What is Not Covered

This limited warranty does not cover any damage, deterioration or malfunction resulting from any alteration, modification, improper or unreasonable use or maintenance, misuse, abuse, accident, neglect, exposure to excess moisture, fire, improper packing and shipping (such claims must be presented to the carrier), lightning, power surges, or other acts of nature. This limited warranty does not cover any damage, deterioration or malfunction resulting from the installation or removal of this product from any installation, any unauthorized tampering with this product, any repairs attempted by anyone unauthorized by Kramer Electronics to make such repairs, or any other cause which does not relate directly to a defect in materials and/or workmanship of this product. This limited warranty does not cover cartons, equipment enclosures, cables or accessories used in conjunction with this product.

Without limiting any other exclusion herein, Kramer Electronics does not warrant that the product covered hereby, including, without limitation, the technology and/or integrated circuit(s) included in the product, will not become obsolete or that such items are or will remain compatible with any other product or technology with which the product may be used.

How Long Does this Coverage Last

One year as of this printing; please check our Web site for the most current and accurate warranty information.

Who is Covered

Only the original purchaser of this product is covered under this limited warranty. This limited warranty is not transferable to subsequent purchasers or owners of this product.

What Kramer Electronics will do

Kramer Electronics will, at its sole option, provide one of the following three remedies to whatever extent it shall deem necessary to satisfy a proper claim under this limited warranty:

1. Elect to repair or facilitate the repair of any defective parts within a reasonable period of time, free of any charge for the necessary parts and labor to complete the repair and restore this product to its proper operating condition. Kramer Electronics will also pay the shipping costs necessary to return this product once the repair is complete.
2. Replace this product with a direct replacement or with a similar product deemed by Kramer Electronics to perform substantially the same function as the original product.
3. Issue a refund of the original purchase price less depreciation to be determined based on the age of the product at the time remedy is sought under this limited warranty.

What Kramer Electronics will not do Under This Limited Warranty

If this product is returned to Kramer Electronics or the authorized dealer from which it was purchased or any other party authorized to repair Kramer Electronics products, this product must be insured during shipment, with the insurance and shipping charges prepaid by you. If this product is returned uninsured, you assume all risks of loss or damage during shipment. Kramer Electronics will not be responsible for any costs related to the removal or re-installation of this product from or into any installation. Kramer Electronics will not be responsible for any costs related to any setting up this product, any adjustment of user controls or any programming required for a specific installation of this product.

How to Obtain a Remedy under this Limited Warranty

To obtain a remedy under this limited warranty, you must contact either the authorized Kramer Electronics reseller from whom you purchased this product or the Kramer Electronics office nearest you. For a list of authorized Kramer Electronics resellers and/or Kramer Electronics authorized service providers, please visit our web site at www.kramerelectronics.com or contact the Kramer Electronics office nearest you.

In order to pursue any remedy under this limited warranty, you must possess an original, dated receipt as proof of purchase from an authorized Kramer Electronics reseller. If this product is returned under this limited warranty, a return authorization number, obtained from Kramer Electronics, will be required. You may also be directed to an authorized reseller or a person authorized by Kramer Electronics to repair the product.

If it is decided that this product should be returned directly to Kramer Electronics, this product should be properly packed, preferably in the original carton, for shipping. Cartons not bearing a return authorization number will be refused.

Limitation on Liability

THE MAXIMUM LIABILITY OF KRAMER ELECTRONICS UNDER THIS LIMITED WARRANTY SHALL NOT EXCEED THE ACTUAL PURCHASE PRICE PAID FOR THE PRODUCT. TO THE MAXIMUM EXTENT PERMITTED BY LAW, KRAMER ELECTRONICS IS NOT RESPONSIBLE FOR DIRECT, SPECIAL, INCIDENTAL OR CONSEQUENTIAL DAMAGES RESULTING FROM ANY BREACH OF WARRANTY OR CONDITION, OR UNDER ANY OTHER LEGAL THEORY. Some countries, districts or states do not allow the exclusion or limitation of relief, special, incidental, consequential or indirect damages, or the limitation of liability to specified amounts, so the above limitations or exclusions may not apply to you.

Exclusive Remedy

TO THE MAXIMUM EXTENT PERMITTED BY LAW, THIS LIMITED WARRANTY AND THE REMEDIES SET FORTH ABOVE ARE EXCLUSIVE AND IN LIEU OF ALL OTHER WARRANTIES, REMEDIES AND CONDITIONS, WHETHER ORAL OR WRITTEN, EXPRESS OR IMPLIED. TO THE MAXIMUM EXTENT PERMITTED BY LAW, KRAMER ELECTRONICS SPECIFICALLY DISCLAIMS ANY AND ALL IMPLIED WARRANTIES, INCLUDING, WITHOUT LIMITATION, WARRANTIES OF MERCHANTABILITY AND FITNESS FOR A PARTICULAR PURPOSE. IF KRAMER ELECTRONICS CANNOT LAWFULLY DISCLAIM OR EXCLUDE IMPLIED WARRANTIES UNDER APPLICABLE LAW, THEN ALL IMPLIED WARRANTIES COVERING THIS PRODUCT, INCLUDING WARRANTIES OF MERCHANTABILITY AND FITNESS FOR A PARTICULAR PURPOSE, SHALL APPLY TO THIS PRODUCT AS PROVIDED UNDER APPLICABLE LAW.

IF ANY PRODUCT TO WHICH THIS LIMITED WARRANTY APPLIES IS A "CONSUMER PRODUCT" UNDER THE MAGNUSON-MOSS WARRANTY ACT (15 U.S.C.A. §2301, ET SEQ.) OR OTHER APPLICABLE LAW, THE FOREGOING DISCLAIMER OF IMPLIED WARRANTIES SHALL NOT APPLY TO YOU, AND ALL IMPLIED WARRANTIES ON THIS PRODUCT, INCLUDING WARRANTIES OF MERCHANTABILITY AND FITNESS FOR THE PARTICULAR PURPOSE, SHALL APPLY AS PROVIDED UNDER APPLICABLE LAW.

Other Conditions

This limited warranty gives you specific legal rights, and you may have other rights which vary from country to country or state to state.

This limited warranty is void if (i) the label bearing the serial number of this product has been removed or defaced, (ii) the product is not distributed by Kramer Electronics or (iii) this product is not purchased from an authorized Kramer Electronics reseller. If you are unsure whether a reseller is an authorized Kramer Electronics reseller, please visit our Web site at www.kramerelectronics.com or contact a Kramer Electronics office from the list at the end of this document.

Your rights under this limited warranty are not diminished if you do not complete and return the product registration form or complete and submit the online product registration form. Kramer Electronics thanks you for purchasing a Kramer Electronics product. We hope it will give you years of satisfaction.

This page is intentionally left blank



For the latest information on our products and a list of Kramer distributors, visit our Web site where updates to this user manual may be found.

We welcome your questions, comments, and feedback.

Web site: www.kramerelectronics.com

E-mail: info@kramerel.com



SAFETY WARNING

Disconnect the unit from the power supply before opening and servicing

P/N:



2900-300395

Rev:



4